

Side

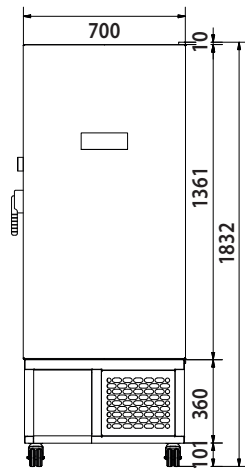

Front

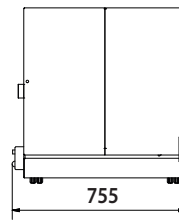

Top

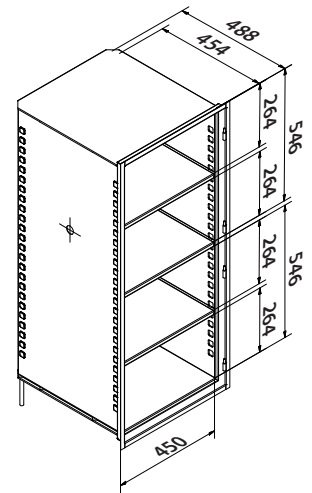

Interior

FREEZER TYPE

VF240-86

Internal dimensions (length x depth x height)	450 x 488 x 1111 mm
External dimensions (length x depth x height)	755 x 740 x 1832 mm
Minimal transport dimensions (doors, elevators, corners)	700 x 740 x 1822 mm
Net weight	245 kg

Shipping details:

Transport weight	330 kg
Transport volume	1,88 m ³
Transport dimensions (packed)	940 x 940 x 2130 mm

ACCESSORIES INVENTORY SYSTEMS

ALUMINIUM RACK (incl. drawers with grip) for: 50 mm/2" boxes.

article	comp. per freezer	drawers per rack	boxes per rack	total boxes	max. box height	
DSA-4603-136G	4	12	4	12	144	60
DSA-9573-136G	2	6	9	27	162	57

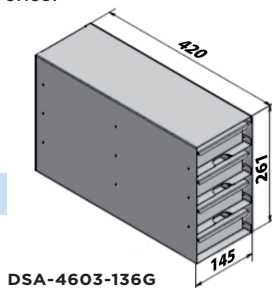

DSA-4603-136G

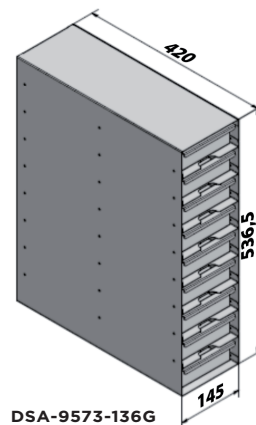

DSA-9573-136G

ALUMINIUM RACK (incl. drawers with grip) for: 75 mm/3" boxes.

article	comp. per freezer	drawers per rack	boxes per rack	total boxes	max. box height	
DSA-3813-136G	4	12	3	9	108	81
DSA-6833-136G	2	6	6	18	108	83

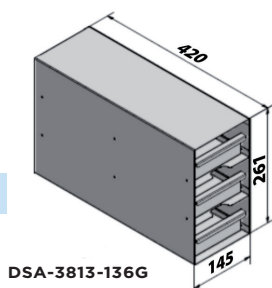

DSA-3813-136G

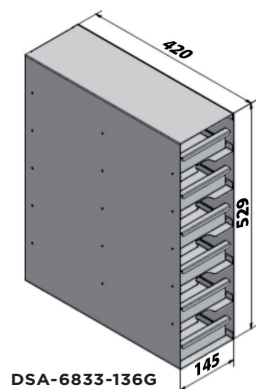

DSA-6833-136G

STAINLESS STEEL RACK (with grips) for: 50 mm/2" and 75 mm/3" boxes.

article	comp. per freezer	total racks	boxes per rack	total boxes	max. box height	
HR-3-4-53	4	12	12/2"	144/2"	53	
HR-3-3-76	4	12	9/3"	108/3"	76	

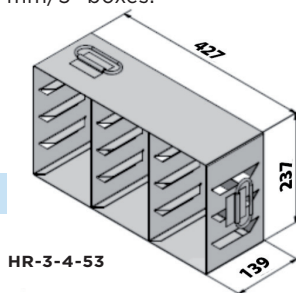

HR-3-4-53

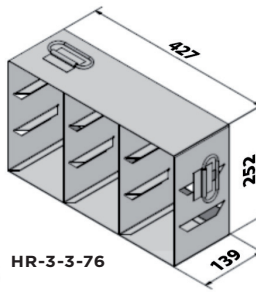

HR-3-3-76

*Specifications subject to change

OPTIONS

CO₂ BACK-UP SYSTEM

Back-up cooling system.

TEMPERATURE RECORDER

7-days/24 hours midi chart recorder, incl. chart paper, pen tip and battery.

NOVO

Text-messenger to pre-programmed mobile phones when controller gives an alarm.

INNER DOORS

Four (4) stainless steel insulated inner doors, optional lockable.

IQ / OQ

Installation and Operation qualification documents.

SNIJERS LABS

Office and Production

Laurent Janssensstraat 105
5048 AR Tilburg
The Netherlands

Showroom and Testfacility

Gebroeders Salastraat 40
5048 AL Tilburg
The Netherlands

T +31 13 750 15 55

F +31 13 463 86 35

info@snijderslabs.com

www.snijderslabs.com

