

Data sheet

Climatic Chamber KK 700 Smart PRO



The photo above is for reference only, may show additional options not included in standard equipment. The real appearance, particularly color and structure of the material may differ from the ones presented in the photo.

Advantages of the SMART PRO controller:

- large (7"), clear, full colour touch screen
- LAN, USB ports and WiFi for communication and data transfer
- multi-segment time and temperature programs
- overview of data in tabular and graphic form
- visual and sound alarm
- Admin function for management
- password protected log-in
- internal memory for programs and data storage
- event registry with user notifications
- LabDesk software and user manual for direct download

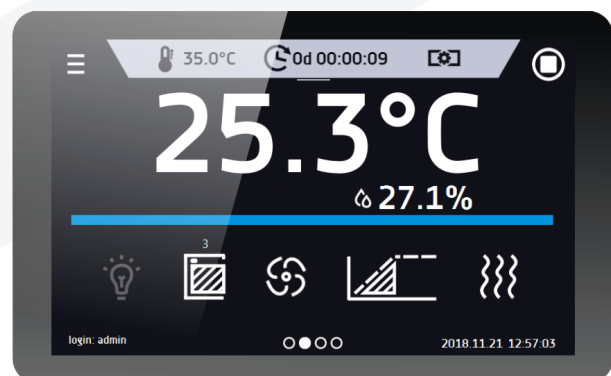

Smart PRO - preview screen

TECHNICAL DATA

air convection	forced
chamber capacity [l]	600
working capacity [l]	485
controller	microprocessor PID
display	7" full colour touch screen

TEMPERATURE AND HUMIDITY

temperature range [°C]	0...+60
temperature resolution every ... [°C]	0,1
temperature variation at 25°C and 60%rH [±/°C]*	2,0
temperature protection	class 3.3 to DIN 12880
relative humidity range [%]	30...90 (see chart for details)
humidity resolution every ... [%]	1,0
humidity variation at 25°C and 60% rH [%rH]	5,0

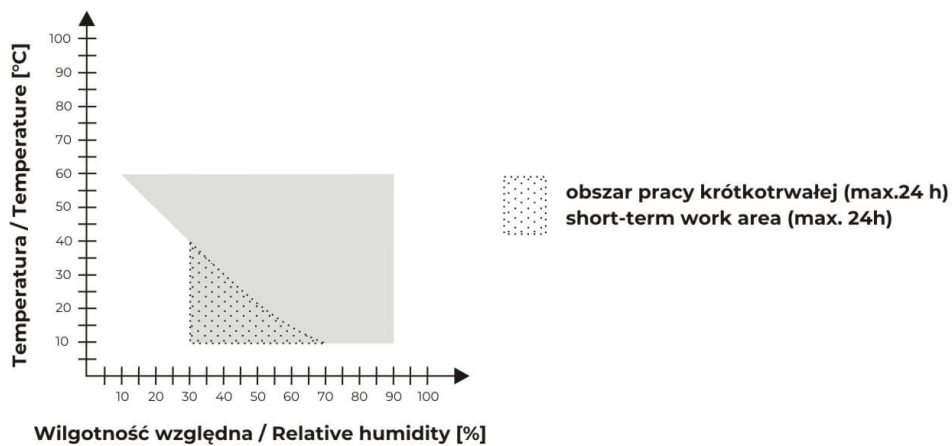

CHAMBER

door type	double (external solid, internal glass) / external glass (option)
interior	
Smart PRO	acid-proof stainless steel to DIN 1.4301
IG Smart PRO	acid-proof stainless steel to DIN 1.4301
housing	
Smart PRO	powder coated sheet
IG Smart PRO	stainless steel linen finish

overall dims [mm] /1/

width A	750
height B	1990
depth C	1140

internal dims [mm]

width D	530
width D'	600
height E	1510
depth F	650
height I	1350

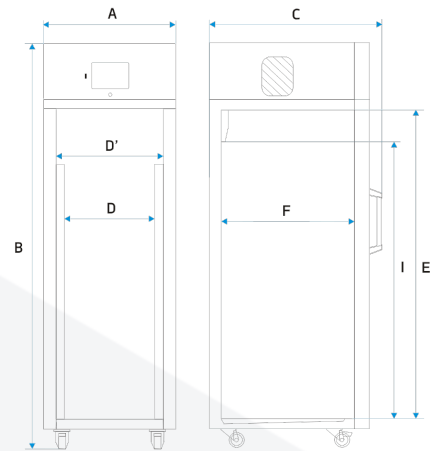

shelves (standard max)	3 11
max shelf workload [kg] /2/	30
- reinforced shelf version (PW) [kg] /3/	100
max unit workload [kg]	150
weight [kg]	170

ELECTRICAL PARAMETERS

voltage**	230V 50-60Hz
nominal power [W]	1850
refrigerant	R290 / GWP=3
warranty	24 months
manufacturer	POL-EKO

all the above technical data refer to standard units (without optional accessories)

* - variation (K) calculated for chamber as: $K = \pm (T \text{ average max.} - T \text{ average min.}) / 2$

** - other power supplies on request

1 - depth doesn't include 50 mm of power cable

2 - on uniformly loaded surface

3 - reinforced shelf

OPTIONS AND ACCESSORIES

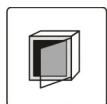

Order number: */A

External glass door







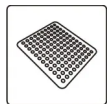

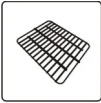
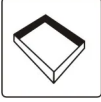

Order number: */P INOX

Stainless steel wire shelf INOX

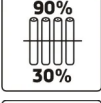
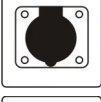

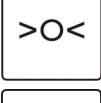
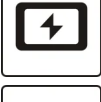
Order number: */PP

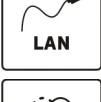
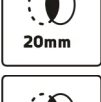
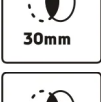
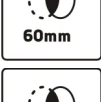
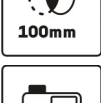
Perforated shelf

	Order number: */PW	Reinforced shelf
	Order number: KUW GN*/*	Stainless steel cuvettes
	Order number: */FIT	Phytotron system
	Order number: FIT/R3	FIT panels independent control
	Order number: GNZ	Internal socket
	Order number: KK/CP	Low water level sensor
	Order number: BRT*/L or IQ/OQ/PQ	Calibration and IQ, OQ, PQ qualification
	Order number: BPP 12	Battery backup for display
	Order number: PORT ALARM	Dry alarm contact
	Order number: LANK	LAN cable
	Order number: OCZ/20	Non-standard access port 20 mm
	Order number: OCZ/30	Additional access port 30 mm
	Order number: OCZ/60	Non-standard access port 60 mm
	Order number: OCZ/100	Non-standard access port 100 mm
	Order number: KK/Z	Container for deionised water
	Order number: KD	Access control